

CONTINUOUS HYDRAULIC TUBE PULLER

3/8"-4"
O.D.



Features :

- Pulling gun communicates with electric powerpack via 9v DC control. This ensures safety and eliminates the need of electrical cord between pump and gun that other manufacturers provide. In pneumatic version communication is via pneumatic control.
- Available with a choice of Electric-TPP System or Pneumatic-PPP System for hazardous, explosive working environments.
- Microprocessor controls on powerpack and gun ensure trouble free life.
- Removes tube without any damage to tube sheet.
- Low setup time and ease of operation.
- High power & High speed automatic cycling, for highest speed of pull available worldwide.
- Auto switchover from low pressure high flow to high pressure low flow on load and again back to low pressure high flow when load is released.
- Automatic slow start feature to minimize risk of breaking tubes and to conserve consumables.
- Compact design of Powerpack and Gun.
- Interchangeable pulling guns with same Powerpack. 15 ton gun for light duty high speed work, 30 ton gun for heavy duty tube pulling and 45 ton gun for tubes upto 3" O.D.
- Pulls up to 3" OD tubes continuously, pulls up to 4" O.D. stub.
- Low maintenance cost and worldwide availability of components.
- Significant saving of time and money over conventional systems.
- Unit is portable with handle and mounted on four wheels for easy handling.
- Unit will pull tubes continuously through the gun effortlessly, needing only one man for operation.

SEQUENCE OF OPERATION

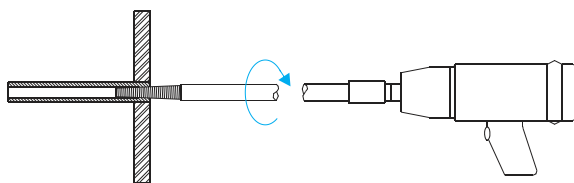

A) Thread mandrel into tube with Impact Wrench

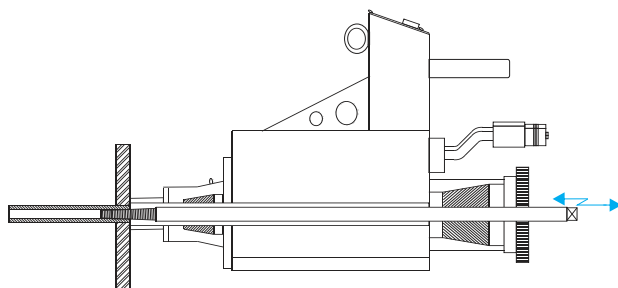
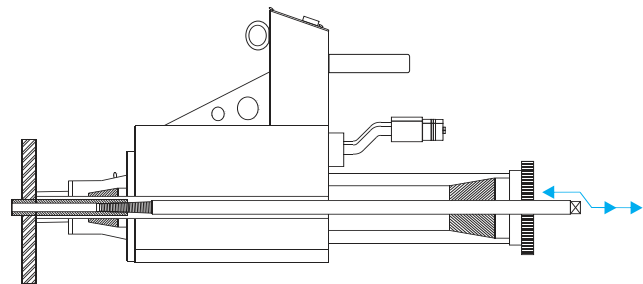

B) Mount Pulling Gun onto mandrel.
Automatic Slow Start to first break expanded joint.

C) Switch to Auto Cycle by pressing 'AUTO' button till tube is completely removed. Gun will continue to cycle till one of the other buttons is pressed. When the tube is free, a tool can be inserted into the jaws to enable the tube to be pulled by hand.

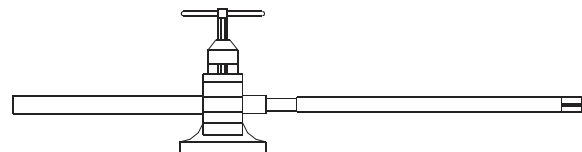

D) Unscrew mandrel from pulled tube and proceed to next tube.

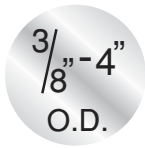

CONTINUOUS HYDRAULIC TUBE PULLER



TPP-50 (Electric) Pump



PPP-50 (Pneumatic) Pump

TUBE PULLING POWERPACK - SPECIFICATIONS



Model	Motor	Volts/Phase	Power hp	Oil Tank Capacity ltrs.	Net Wt. kgs.	Dim. mm	Air Supply	Hyd.Hoses Size x Length inch x mtrs.
TPP-50	Siemens	415 / 3	5	90	220	1200 x 750 x 990	-	1/2"x5 & 3/4"x5
TPP-30	Siemens	230 / 1	3	12	42	500 x 410 x 750	-	1/2"x5 & 3/4"x5
PPP-50 (Pneumatic)	Gast	-	9	90	220	1200 x 750 x 990	180CFM AT 7 BAR	1/2"x5 & 3/4"x5

Note : Max. Working Pressure 350 Bar
ALL Powerpacks supplied with 5 mtr. long hydraulic hoses.

HYDRAULIC TUBE PULLING GUNS (ELECTRIC) - SPECIFICATIONS



Gun Model	Pulling Capacity tons	Max. Tube O.D. Thru Gun inch	Stub Pulling Capacity inch	Weight		Free Pulling Speed (meter/min) with		
				kgs.	lbs.	TPP-50	TPP-30	PPP-50
HPG-15	15	1	1.1/2	26	57	5.2	1.8	5.6
HPG-30	30	1.1/2	3	38	84	3.0	2.4	3.5
HPG-45	45	3	4	78	172	2.0	2.0	2.3



HYDRAULIC TUBE PULLING GUNS (PNEUMATIC) - SPECIFICATIONS



Gun Model	Pulling Capacity tons	Max. Tube O.D. Thru Gun inch	Stub Pulling Capacity inch	Weight		Free Pulling Speed (meter/min) with		
				kgs.	lbs.	TPP-50	TPP-30	PPP-50
AHPG-15	15	1	1.1/2	26	57	5.2	1.8	5.6
AHPG-30	30	1.1/2	3	38	84	3.0	2.4	3.5
AHPG-45	45	3	4	78	172	2.0	2.0	2.3

Note : All pulling guns are supplied with Forward, Reverse, and Auto Cycle Switches.

ACCESSORIES FOR CONTINUOUS TUBE PULLER

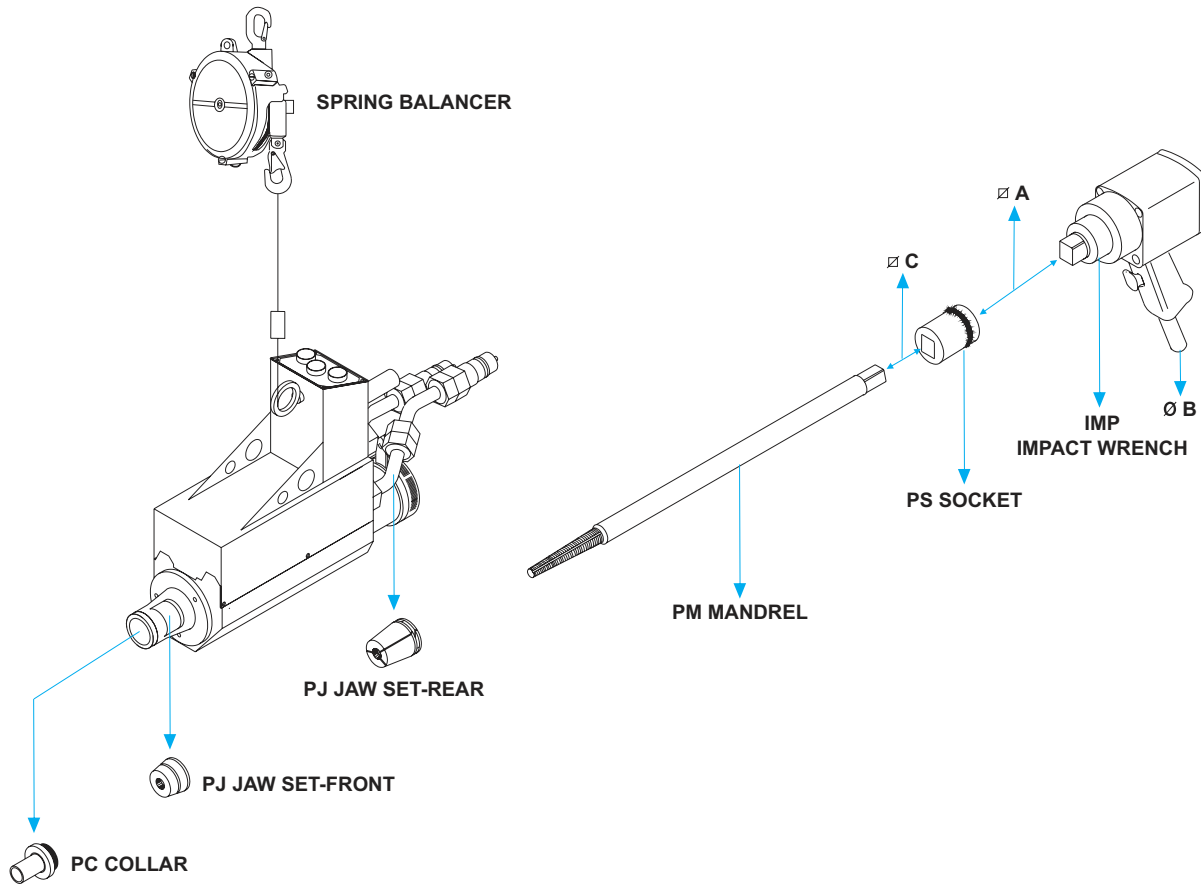

SPRING BALANCER

- Used to suspend pulling guns for 'feather touch', operation.
- Frees the operator from handling weight of the gun, allowing him to concentrate on the tube pulling operation.

Model	Balancer Range		For Pulling Gun Model	Weight	
	kg	lbs		kgs.	lbs.
SWF-30	20 - 30	44 - 66	HPG-15 / AHPG-15	9.5	21.0
SWF-40	30 - 40	66 - 88	HPG-30 / AHPG-30	10.5	23.1
SWF-85	70 - 85	154 - 187	HPG-45 / AHPG-45	15.0	33.0

IMP - IMPACT WRENCH

- Used to thread PM mandrels into tube with help of sockets.

Model	Suited For Mandrel Model Numbers	Weight		∅ A	∅ B
		kg	lbs		
IMP-1	PM-7 to PM-37	5.0	11.0	3/4"	3/8"
IMP-2	PM-19 to PM-95/102	10.5	23.0	1"	1/2"

PS - SOCKET

- Used to connect impact wrench to pulling mandrel.

Model	∅ A	∅ C
PS-1	3/4"	3/8"
PS-2	3/4"	1/2"
PS-3	3/4"	5/8"
PS-4	3/4"	3/4"
PS-5	3/4"	1"
PS-6	1"	3/4"
PS-7	1"	1"
PS-8	1"	1.1/2"

WORKING CONSUMABLES - CONTINUOUS TUBE PULLER

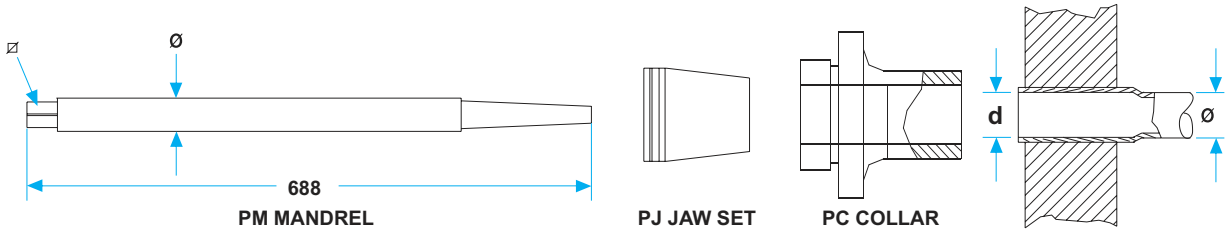

Tube Size		Tube I.D. after Expansion d		Mandrel		Jaw Set			Collar		
Ø	bwg	mm	inch	Model	Square Size	Model For HPG-15	Model For HPG-30	Model For HPG-45	Model For HPG-15	Model For HPG-30	Model For HPG-45
				PM	∅	PJ 15	PJ 30	PJ 45	PC 15	PC 30	PC 45
3/8"	17-19	6.5-7.5	0.260-0.295	7	5/16"	1	1		11	11	
	20-24	7.5-8.5	0.295-0.335	8							
1/2"	14-16	8.5-9.5	0.335-0.375	9	3/8"	2	2		15	15	
	17-18	9.5-10.5	0.375-0.415	10							
	19-21	10.5-11.5	0.415-0.455	11							
	24	11.5-12.5	0.455-0.495	12							
5/8"	16-17	12.5-13.5	0.495-0.535	13 A	1/2"	3	3		18	18	
	19-21	13.5-14.5	0.535-0.570	14 A							
	23-24	14.5-15.5	0.570-0.610	15 A							
3/4"	11	12.5-13.5	0.495-0.535	13	5/8"	4	4		21	21	
	12-13	13.5-14.5	0.535-0.570	14							
	14-15	14.5-15.5	0.570-0.610	15							
	16-17	15.5-16.5	0.610-0.650	16							
	18-20	16.5-17.5	0.650-0.690	17							
	21-24	17.5-18.5	0.690-0.730	18							
7/8"	14	17.5-18.5	0.690-0.730	18 S	5/8"	4/A	4/A		25	25	
	16-17	18.5-19.5	0.730-0.770	19 S							
	18-19	19.5-20.5	0.770-0.810	20 S							
1"	10-11	18.5-19.5	0.730-0.770	19	3/4"	5	5	5	28	28	28
	12	19.5-20.5	0.770-0.810	20							
	13-14	20.5-21.5	0.810-0.845	21							
	15-16	21.5-22.5	0.845-0.885	22							
	18	22.5-23.5	0.885-0.925	23							
	19-20	23.5-24.5	0.925-0.965	24							
3/4" Gas	13	21.5-22.5	0.845-0.886	22 G				6	6		31
	14-15	22.5-23.5	0.886-0.925	23 G							
	16-17	23.5-24.5	0.925-0.965	24 G							
	19-21	24.5-25.5	0.965-1.005	25 G							
1.1/4"	10	24.5-25.5	0.965-1.005	25	1"			7	7		34
	11-12	25.5-26.5	1.005-1.045	26							
	13	26.5-27.5	1.045-1.085	27							
	14-15	27.5-28.5	1.085-1.125	28							
	16-18	28.5-29.5	1.125-1.160	29							
	19-22	29.5-30.5	1.160-1.200	30							
1" Gas	9	25.5-26.5	1.005-1.045	26 G				8	8		37
	10	26.5-27.5	1.045-1.085	27 G							
	11-12	27.5-28.5	1.085-1.125	28 G							
	13-14	28.5-29.5	1.125-1.160	29 G							
1.1/2"	10-11	31.5-32.5	1.240-1.280	32				9	9		41
	12-13	32.5-33.5	1.280-1.320	33							
	14	33.5-34.5	1.320-1.360	34							
	15-17	34.5-35.5	1.360-1.400	35							
	18-20	35.5-36.5	1.400-1.440	36							
	21-24	36.5-37.5	1.440-1.475	37							

Note : All models indicated above are for continuous tube pulling. When you are using equipment for stub pulling, please contact us for modifications needed.

WORKING CONSUMABLES - CONTINUOUS TUBE PULLER

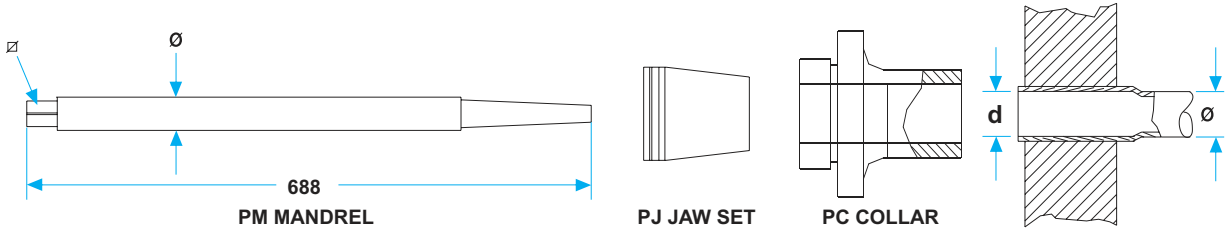

Tube Size		Tube I.D. after Expansion D		Mandrel		Jaw Set			Collar		
OD / Ø	bwg	mm	inch	Model	Square Size	Model For HPG-15	Model For HPG-30	Model For HPG-45	Model For HPG-15	Model For HPG-30	Model For HPG-45
				PM	∅	PJ 15	PJ 30	PJ 45	PC 15	PC 30	PC 45
1.1/4" Gas	12	36.5-37.5	1.440-1.475	37G	1"		10	10		44	44
	13-14	37.5-38.5	1.475-1.515	38G							
	15-16	38.5-39.5	1.515-1.555	39G							
	17-19	39.5-40.5	1.555-1.595	40G							
	20-24	40.5-41.5	1.595-1.635	41G							
1.3/4"	10-11	37.5-38.5	1.475-1.515	38/44							
	12	38.5-39.5	1.515-1.555	39/44							
	13-14	39.5-40.5	1.555-1.595	40/44							
	15-16	40.5-41.5	1.595-1.635	41/44							
	18-19	41.5-42.5	1.635-1.675	42/44							
	20-24	42.5-43.5	1.675-1.715	43/44							
1.1/2" Gas	11-12	42.5-43.5	1.715-1.755	43G							
	13-14	43.5-44.5	1.755-1.795	44G							
	15-17	44.5-54.5	1.795-1.830	45G							
	18-19	45.5-46.5	1.830-1.870	46G							
2"	10	43.5-44.5	1.830-1.870	44/51							
	11-12	44.5-45.5	1.870-1.910	45/51							
	13	45.5-46.5	1.910-1.950	46/51							
	14-15	46.5-47.5	1.950-1.990	47/51							
	16-18	47.5-48.5	1.870-1.910	48/51							
	19-22	48.5-49.5	1.910-1.950	49/51							
2.1/4"	9-10	49.5-50.5	1.950-1.990	50/57							
	11	50.5-51.5	1.990-2.030	51/57							
	12-13	51.5-52.5	2.030-2.070	52/57							
2" Gas	7	50.5-51.5	1.990-2.030	51G							
	8	51.5-52.5	2.030-2.070	52G							
	9	53.5-53.5	2.070-2.105	53G							
2.1/2"	7	53.5-54.5	2.015-2.145	54/63							
	8	54.5-55.5	2.145-2.185	55/63							
	9	55.5-56.5	2.185-2.225	56/63							
	10	56.5-57.5	2.225-2.265	57/63							
3"	7	66.5-67.5	2.580-2.620	67/76							
	8	67.5-68.5	2.620-2.660	68/76							
	9-10	68.5-69.5	2.660-2.695	69/76							
	11	69.5-70.5	2.695-2.735	70/76							

Note : For Tubes larger than 3" O.D., please contact us for larger size working consumables and larger size tube pulling guns.
All models indicated above are for continuous tube pulling. When you are using equipment for stub pulling, please contact us for modifications needed.